

SBGN-Discussion

LIBSBGN

What's next

- Release (Soon - October 2011)
- More detailed graphics
 - Roundness of rounded rectangles
 - Arrow-glyph size
 - Line thickness
 - ...
- Better handling of submaps

WISHES?

SBGN-ML roadmap

- Milestone 1 released (Jan. 2011)
 - Only support for SBGN PD
 - Only high-level graphics specification
 - Basic validation using XML Schema
- Milestone 2 (planned for Oct. 2011)
 - Implement semantics for all 3 languages: SBGN PD, ER and AF
 - Extra validation using Schematron
 - Third-party extensibility
- Milestone 3
 - Complete graphical specification
 - Submaps...
- Milestone 4
 - Linking, MIRIAM compatibility, ...

WISHES?

PROCESS DESCRIPTION

For Discussion: Reversible Arcs

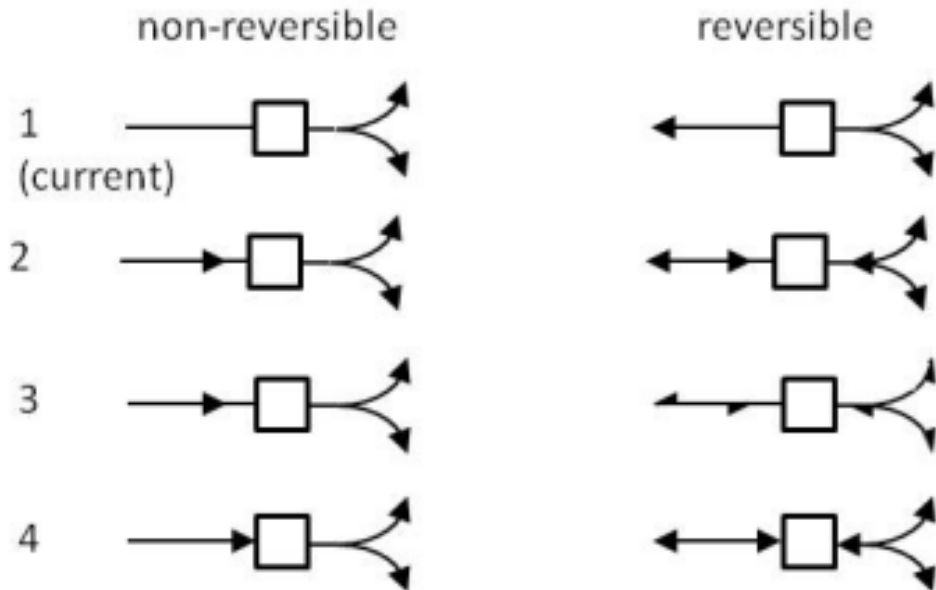

Complex Identity

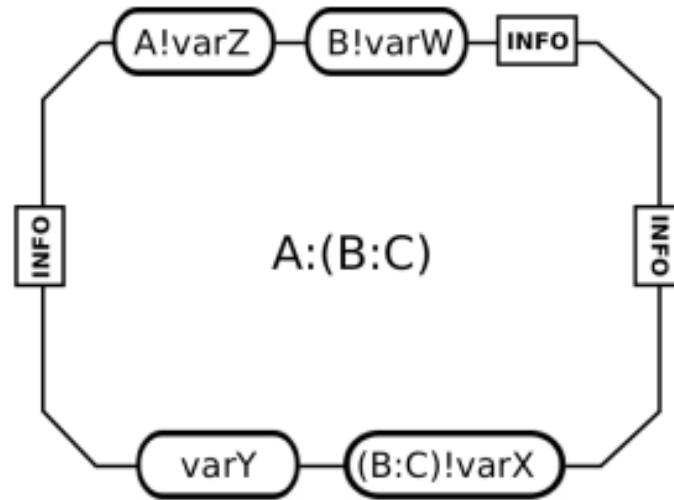
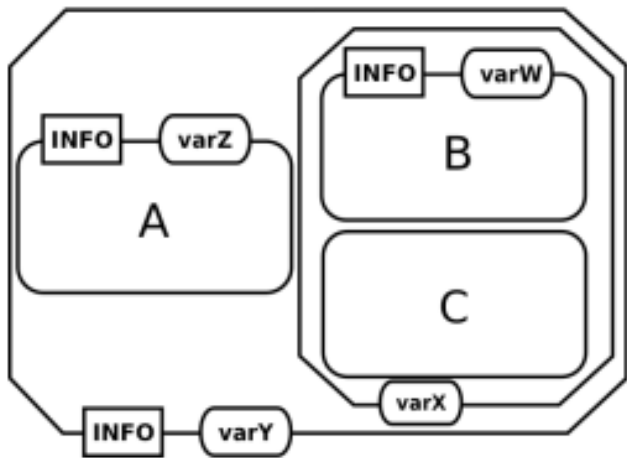
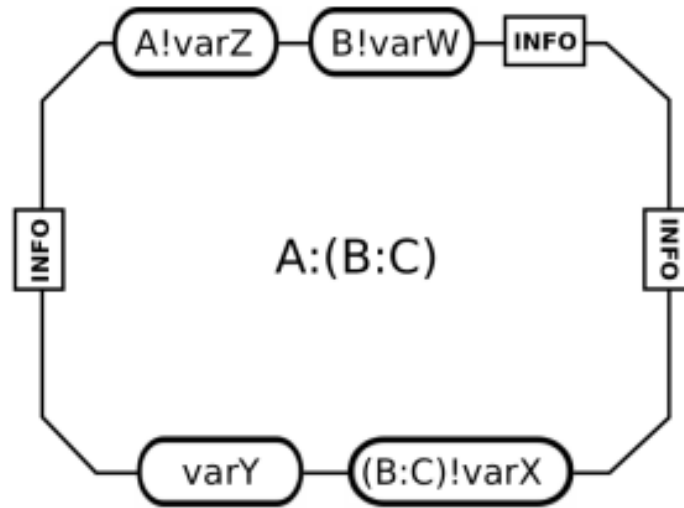
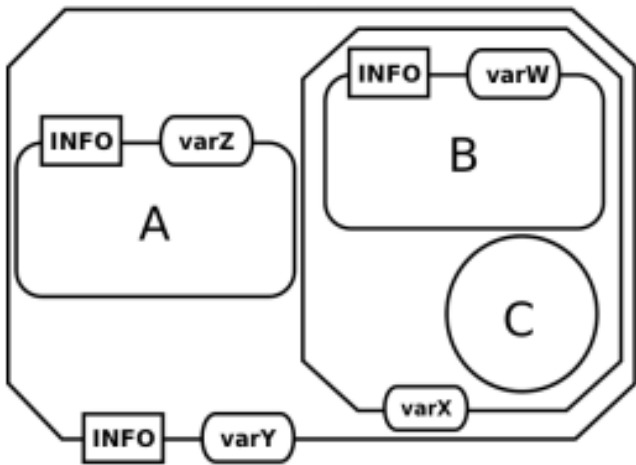

Are glyphs inside decorators?

Material type vs. conceptual type

- indicates its chemical structure according to SBO
- indicates its function

Name	Label
Non-macromolecular ion	mt:ion
Non-macromolecular radical	mt:rad
Ribonucleic acid	mt:rna
Deoxyribonucleic acid	mt:dna
Protein	mt:prot
Polysaccharide	mt:psac

Name	Label
Gene	ct:gene
Transcription start site	ct:tss
Gene coding region	ct:coding
Gene regulatory region	ct:grr
Messenger RNA	ct:mRNA

Material Type

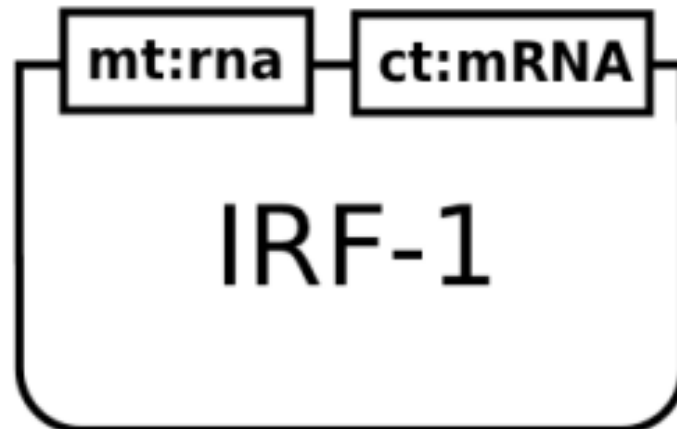
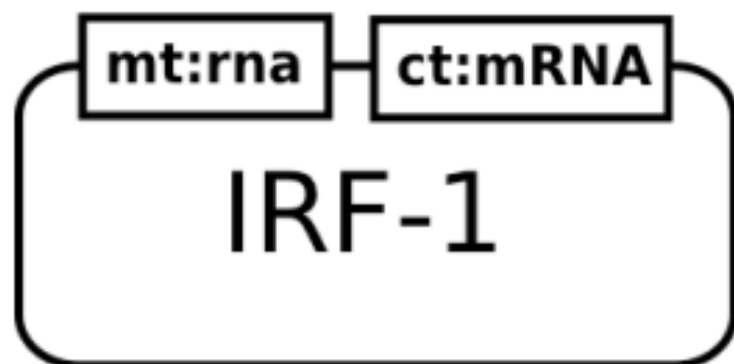

Unit of information vs. annotation

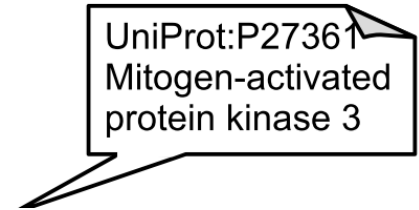
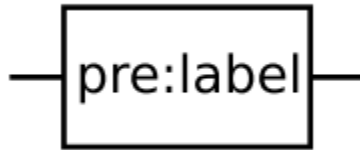

SPEC:

The unit of information is a decoration that can be used in this situation to add information to a glyph.

AS: The benefit of Uoi is its size. Annotation glyph is **too big** to be used with all EPNs on the map, but Uoi is compact and can be drawn on each element of the diagram.

NIN: It seems that we are moving towards a situation where ***every decoration*** is an attribute, including the unit of information, that all must have the form prefix:value. Is-there any unit of information that is not following that pattern?

NIN: **ENV!mt:rna!ct:gene** and **ENV!mt:dna!ct:gene?** those should not be used to defined the identity of the EPNs. We should label them, in my example as vENV and cENV for instance (for viral and cellular).

Cardinality Glyph

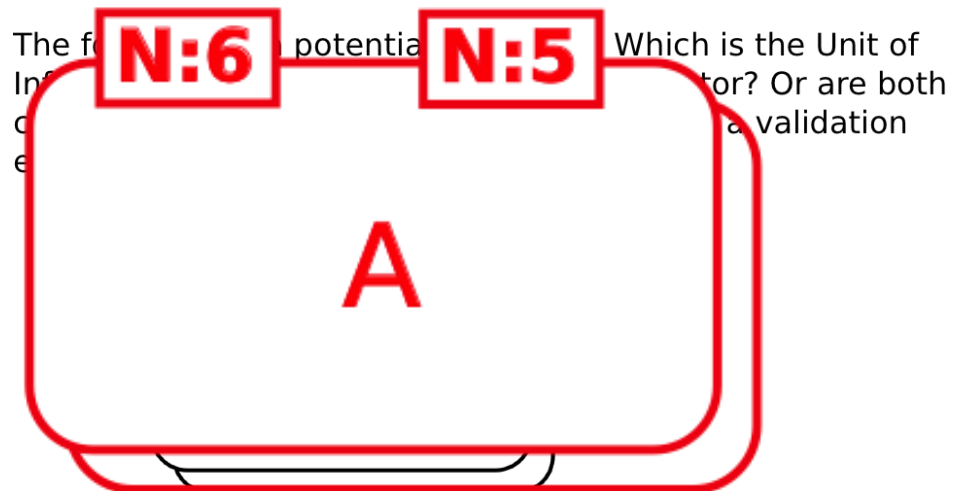
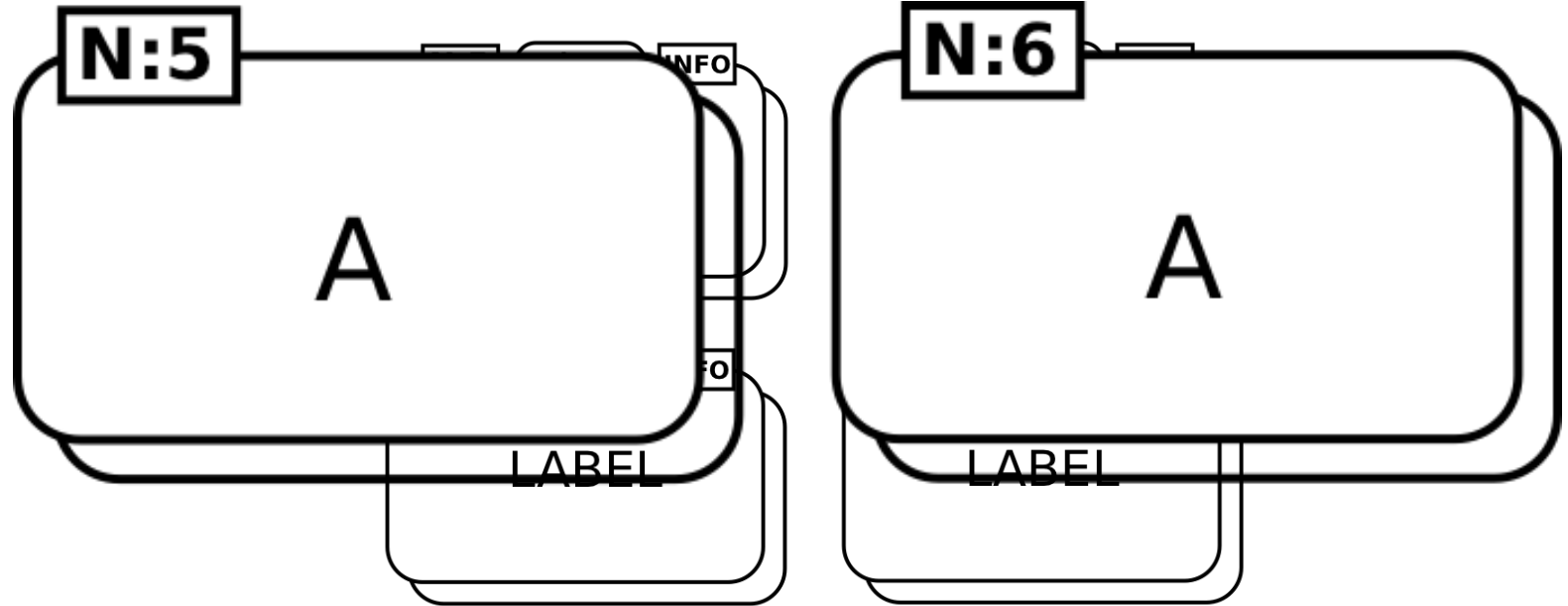

Identity of Logic Gates

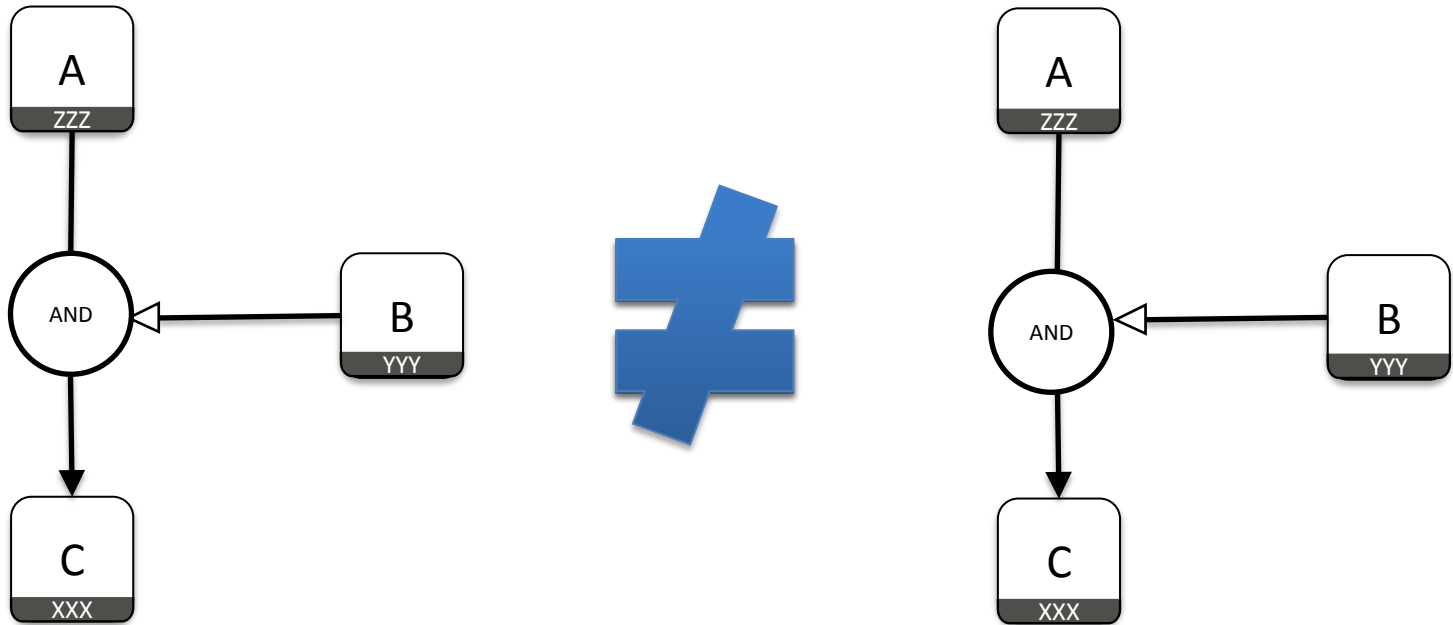

ENTITY RELATIONSHIP

Should a group have a label?

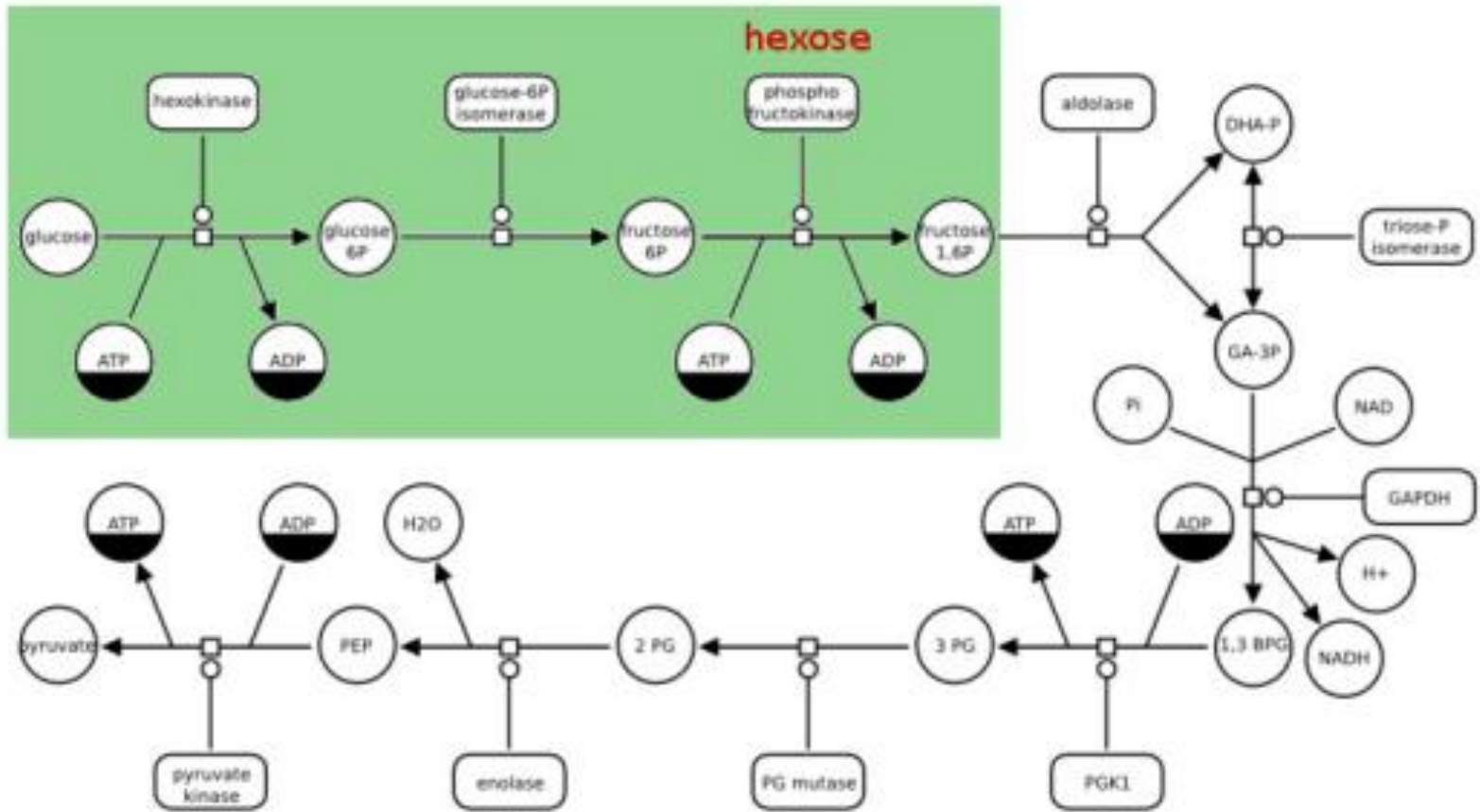

Should a group have an annotation?

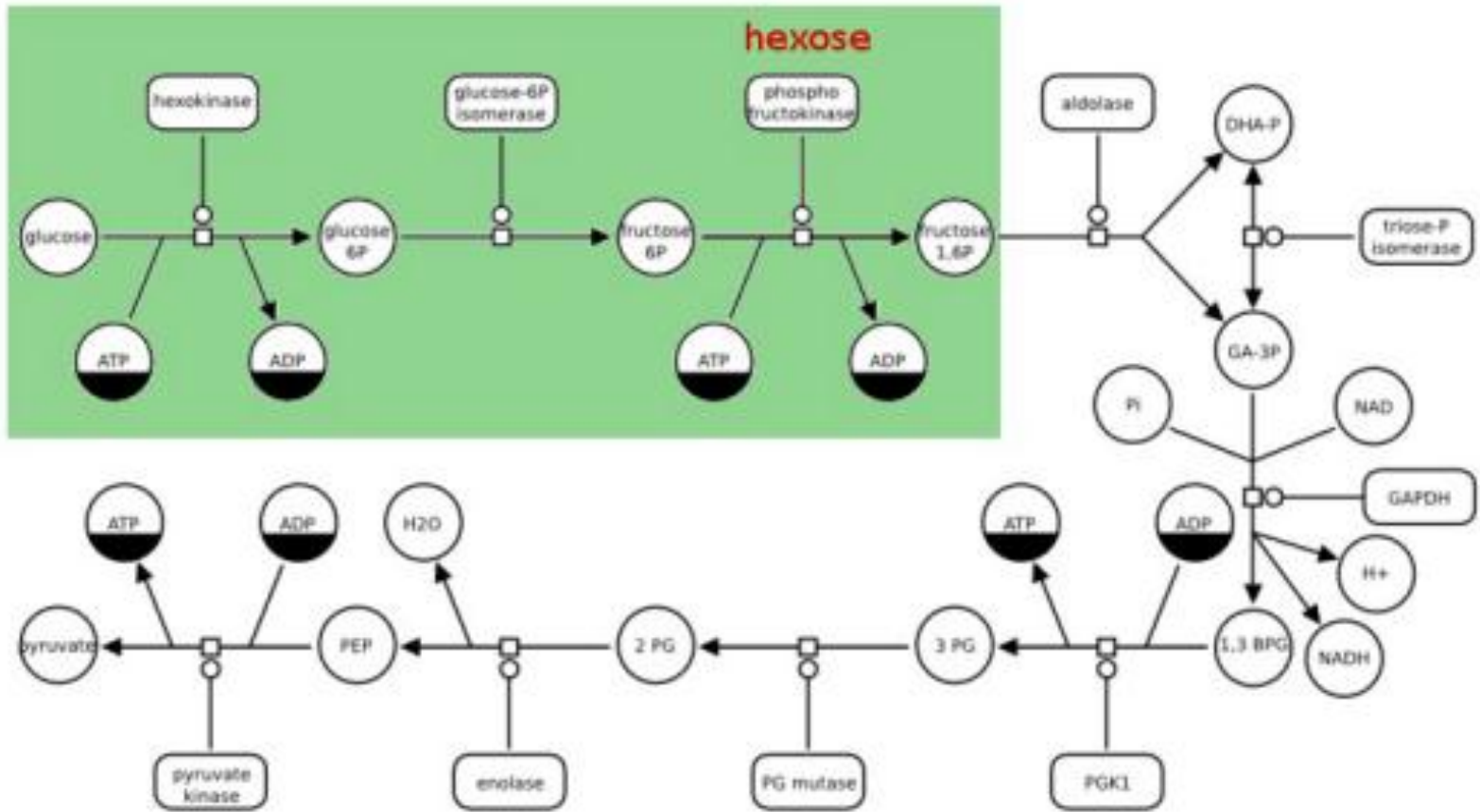

Continuant Vs occurrent outcomes

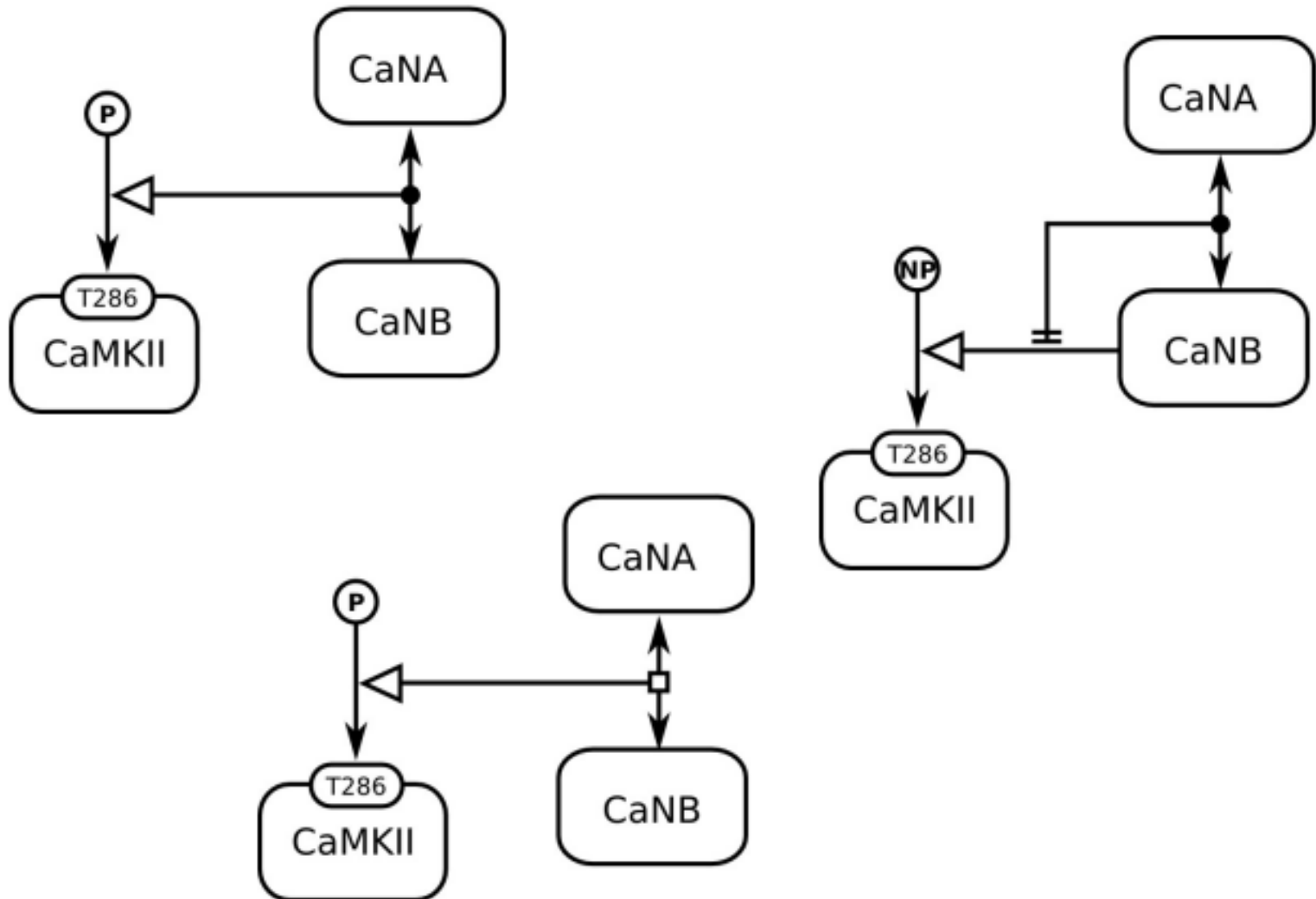

Outcome on influences

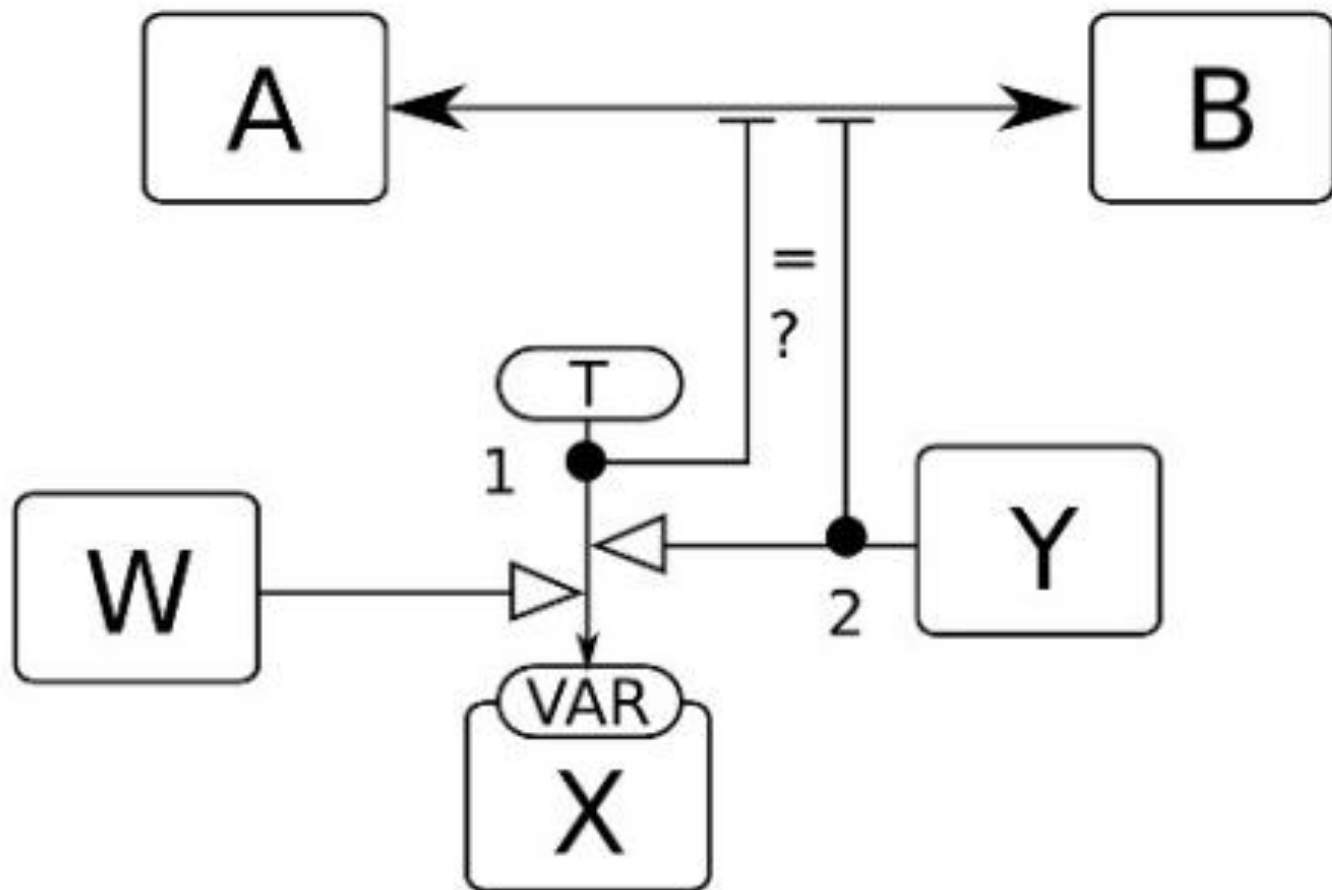

Why do we need delay?



Reduction?

- Show several activations in one arc?
- Details in annotations?

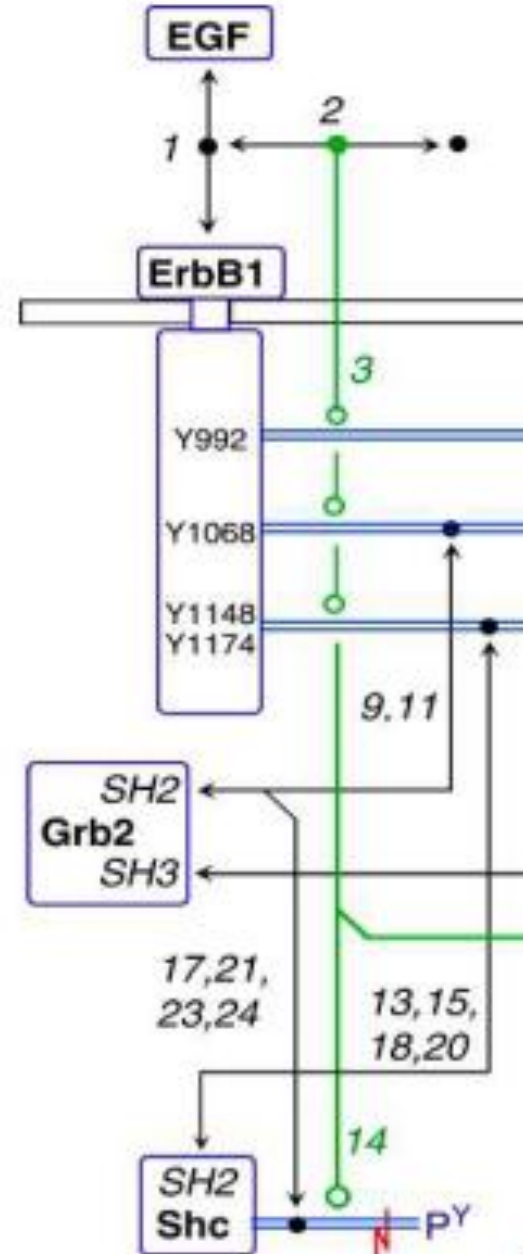

Dephosphorylation of unprotected tyrosine residues

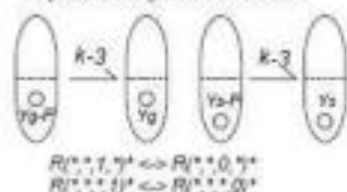

Grb2 binding to receptor phosphotyrosine

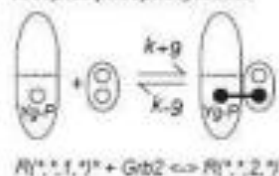

Grb2-Sos binding to receptor phosphotyrosine

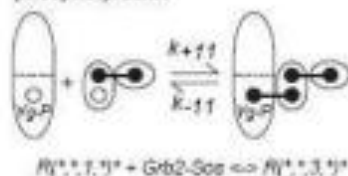

Shc transphosphorylation by receptor kinase

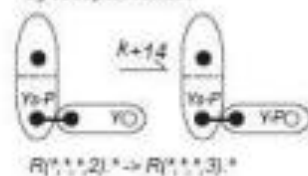

Sos binding to Grb2 associated with receptor phosphotyrosine

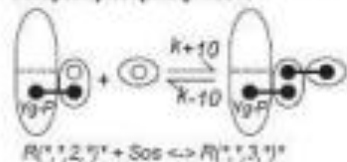

Shc binding to receptor phosphotyrosine

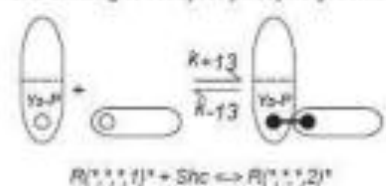

ShcP binding to receptor phosphotyrosine

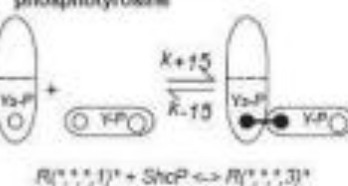

Shc dephosphorylation

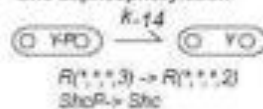

Grb2 recruited to ShcP associated with receptor

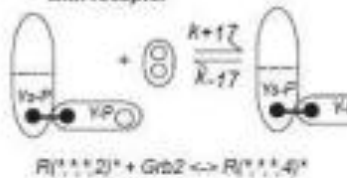

ShcP-Grb2-Sos binding to receptor phosphotyrosine

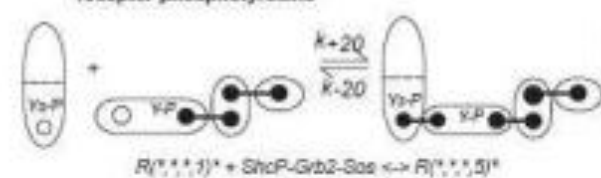

ShcP and Grb2 binding in cytosol

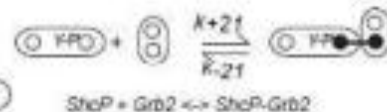

ShcP-Grb2 binding to receptor phosphotyrosine

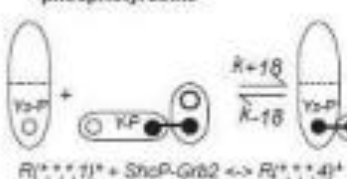

Grb2-Sos binding to ShcP associated with receptor phosphotyrosine

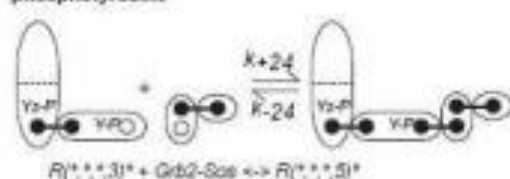

ShcP and Grb2-Sos binding in cytosol

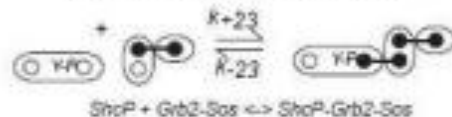

Sos binding to ShcP-Grb2 associated with receptor phosphotyrosine

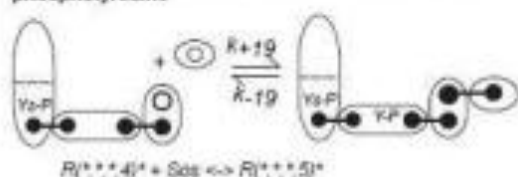

ShcP-Grb2 and Sos binding in cytosol

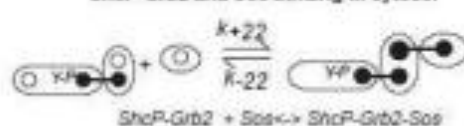

ER?

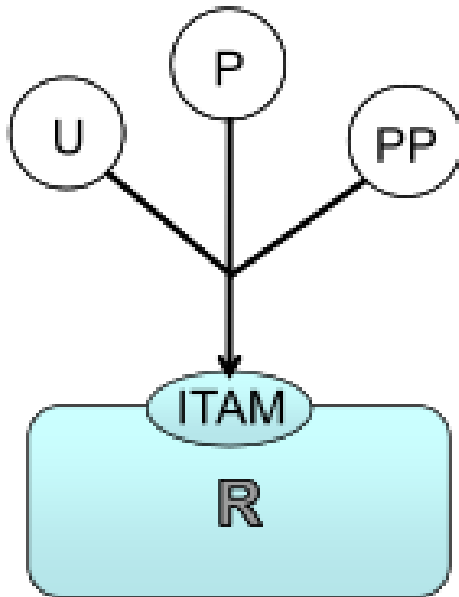

$$R(\text{ITAM} \sim \text{U}) \leftrightarrow R(\text{ITAM} \sim \text{P}) \quad p, d$$

$$R(\text{ITAM} \sim \text{P}) \leftrightarrow R(\text{ITAM} \sim \text{PP}) \quad 0.1 * p, 0.1 * d$$

$$R(\text{ITAM} \sim \text{PP}) \rightarrow R(\text{ITAM} \sim \text{U}) \quad 0.01 * d$$